

Rev:02/05/14  
Designed by:  
Ritchie Kinmont

Project #56 Page 1/20  
Sonic Micro Crossbow



## Sonic Micro Crossbow

### About this project:

The Sonic Micro Crossbow is a great project for kids ages 4 and up. Younger kids may need some help cocking the crossbow. The limbs of the bow are spring steel, making it robust and powerful for its size. This crossbow shoots modified cotton swabs. Wood matches can also be used with adult supervision. This project includes instructions for the crossbow, bolts, and a target.

This micro design may be small . . . but this little baby can really send the bolts flying! Use the included target to sharpen your Sonic crossbow skills. . . cool!



Rev:02/05/14

## What's it made of?

The Sonic Micro Crossbow is made from regular popsicle sticks for the frame, metal hair clips for the bow limbs, and embroidery floss for the bow string and grip wrap. The bolts are made from cotton swabs. Kitchen matches can also be used as bolts, outdoors with adult supervision.

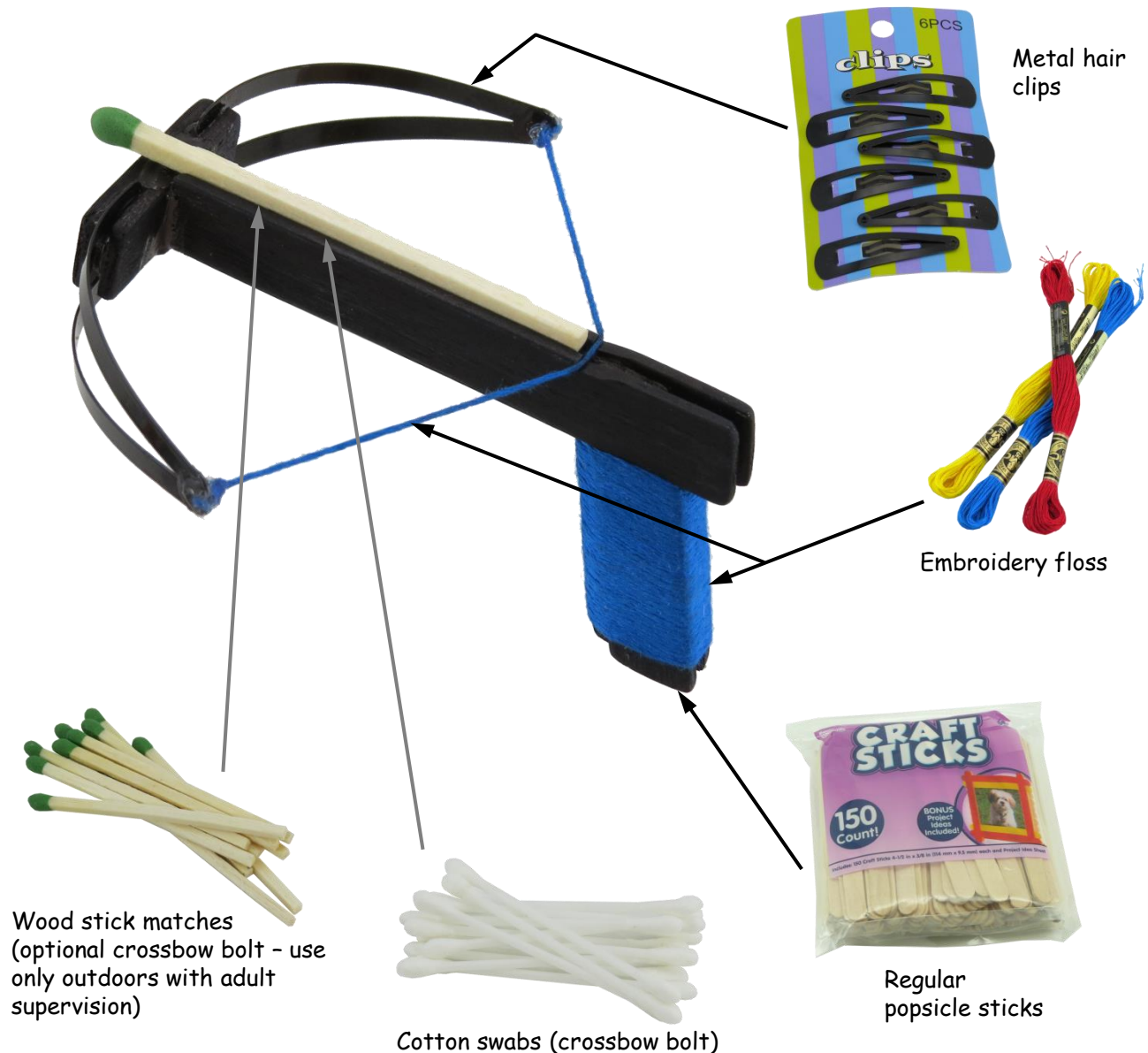

Rev:02/05/14

## What's it made of?

The Sonic Micro Crossbow target is made from regular popsicle sticks for the support, with poster board and an ink jet printer label for the target graphic.

Poster board



Ink jet labels



Regular popsicle sticks

## Project Construction



Check out my way cool Sonic Dad gauges for project difficulty, time, and cost. Cost of this project depends on how many items you have on hand. If you purchase all items new, cost will be higher than the approximate cost shown.

### SHOPPING LIST

Quantity	Item needed	Where to find it	See Page/Figure
1 pkg	Regular popsicle sticks	Wal-Mart, craft store	Page 2, A, B
2	Metal hair clips	Wal-Mart, grocery store	Page 2, S, T
1 pkg	Embroidery floss, color of your choice	Wal-Mart (crafts/sewing section)	Page 2, Z, AA
1	Avery full sheet ink-jet printer label #48165	Wal-Mart, discount retail store, office supply store	Page 3, OO, PP
1	Piece of poster board or other thin cardboard 3" x 3"	Wal-Mart, discount retail store	Page 3, OO
As required	Cotton swabs – crossbow bolt (plastic stick preferred)	Dollar tree, grocery store	Page 2, 17
Optional	Large wood stick matches – crossbow bolt (use only with adult supervision)	Wal-Mart, grocery store	Page 2, 17

Rev:02/05/14

SUPPLIES AND TOOLS NEEDED	
Item needed	Where to find it
Scissors	Discount retail store, home improvement store
Heavy duty shears (for cutting popsicle sticks)	Discount retail store, home improvement store
High temp hot glue gun and glue sticks	Discount retail store, home improvement store, craft store
X-acto knife with sharp blades	Discount retail store, home improvement store
Mechanical pencil for marking	Discount retail store
150 and 400 grit sand paper	Discount retail store, home improvement store
Black permanent marker	Discount retail store, home improvement store
Measuring tape or ruler	Discount retail store, home improvement store
Toothpick or other small pointed object	On hand

### Step 1

Select five or six regular size popsicle sticks from your supply. Choose sticks that are straight, flat, and free from blemishes and knots as shown. (fig. A)

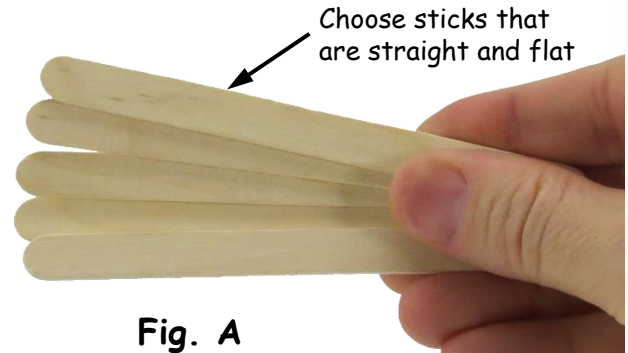
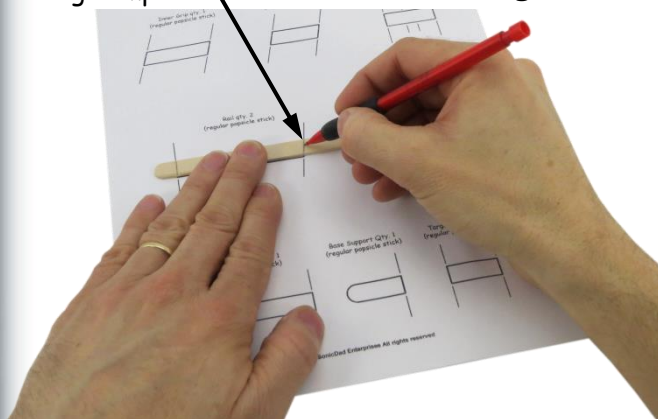

Fig. A

Mark cut lines using template

Fig. B



### Step 2

Print the cutting template from page 19 on regular printer paper. Lay the template sheet on your work surface. Lay the popsicle sticks on the template and use a pencil to mark the cut lines on the pieces required, as indicated on the template. Mark the center location lines on one of the limb support pieces using the template. (fig. B)

Cut on marked lines

fig. C

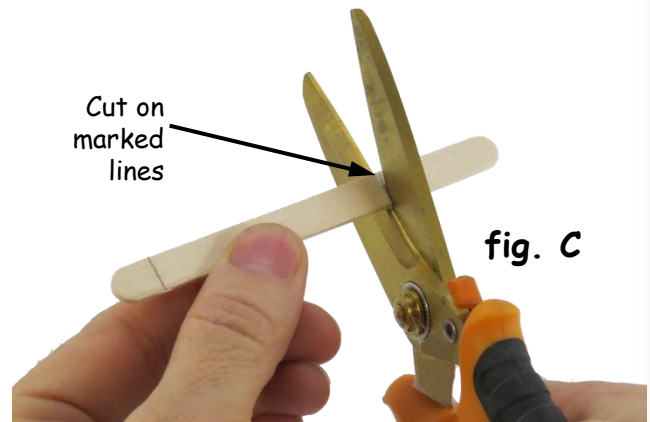

### Step 3

Use heavy duty shears, kitchen shears, or tin snips to cut the popsicle sticks on the cut lines as shown. (fig. C)

Rev:02/05/14

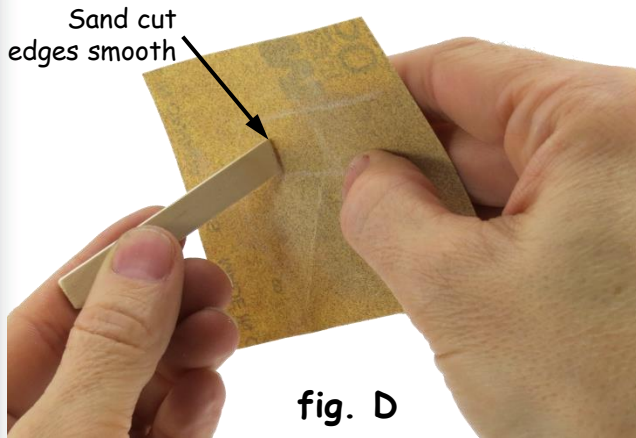

### Step 4

Use a piece of 150 grit sandpaper to smooth the rough cut edges on each piece. (fig. D)

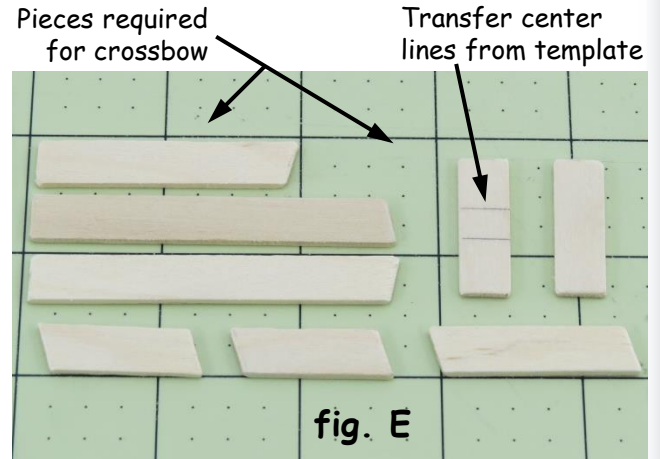

### Step 5

When you have cut and sanded all the pieces required for the crossbow, lay them out to double check your pieces and quantities. You should have all the pieces shown. Be sure you have marked the center location lines on one of the limb supports as shown. The pieces shown are for constructing the crossbow; if you will also be building the target, please refer to sheet 19 for the additional pieces required. (fig. E)

### Step 6

Use a pair of scissors to remove the cotton tips from each end of a cotton swab. Use the swab stick as a gage to determine the position of the rail spacer for marking. Hold the rail spacer and one rail piece as shown. Position the spacer so the center of the swab stick is even with the top surface of the rail on both ends as shown. This will establish the correct slot depth for your crossbow frame. (fig. F)

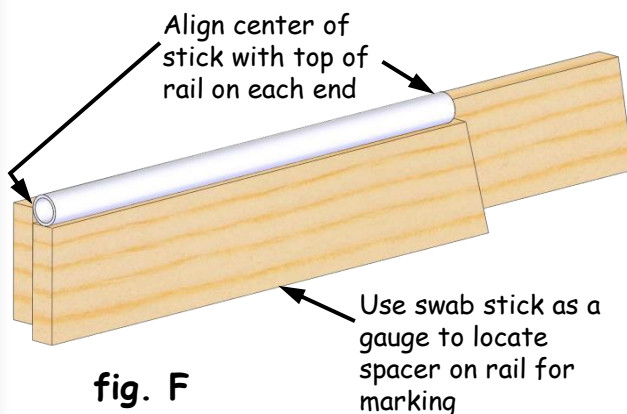

Mark spacer location line on rail

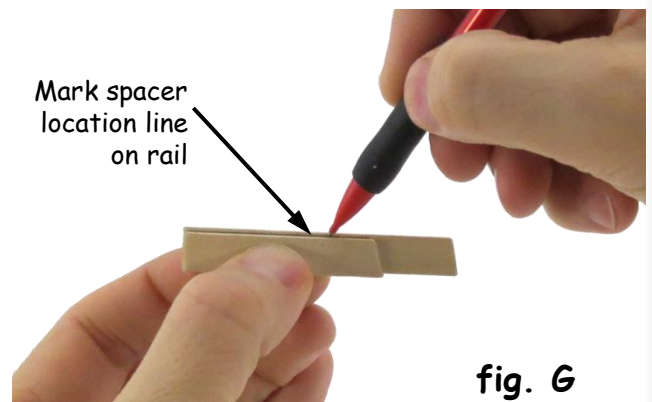

### Step 7

Carefully keeping the two pieces clamped together, remove the swab stick and mark a line on the rail across the top of the spacer using a mechanical pencil as shown. (fig. G)

Apply thin bead of glue on rail

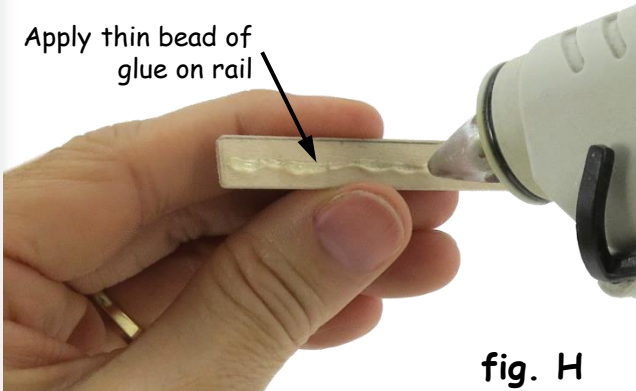

fig. H

### Step 8

Apply a thin bead of high-temp hot glue in the center of the rail for attaching the spacer as shown. (fig. H)



### Step 9

Working quickly while the glue is still hot, attach the spacer to the rail exactly on the marked line and flush with the front of the rail as shown. After the glue cools, double check the spacer position using the swab stick as before. The center of the stick should be even with the top of the rail on each end as shown. (fig. I)

This the perfect glue bead size for attaching the spacer to the rail. A larger bead could squeeze out and make a mess. The only trick with a smaller bead like this is, it will cool down a little faster. So be ready to attach the spacer exactly on your marked line before the glue begins to cool. I like to do a practice dry run without glue first, just like checking the magnetos on my plane before I take off!

After glue cools double check the spacer position with swab stick

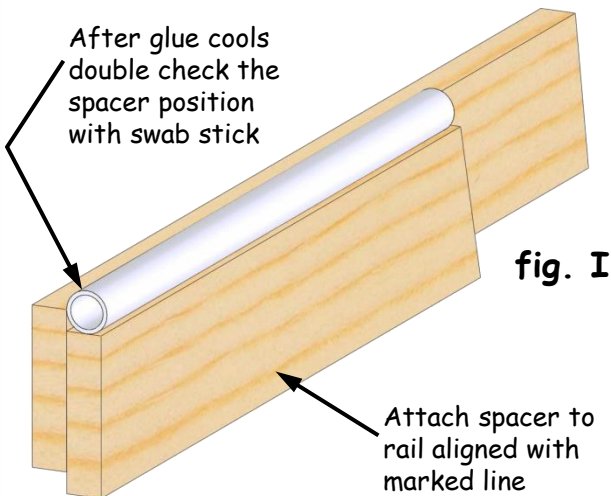

fig. I

### Step 10

Use a small bead of glue to attach the inner grip piece in the location shown. Be sure the top edges of the spacer and grip piece are flush. (fig. J)

Attach even with spacer

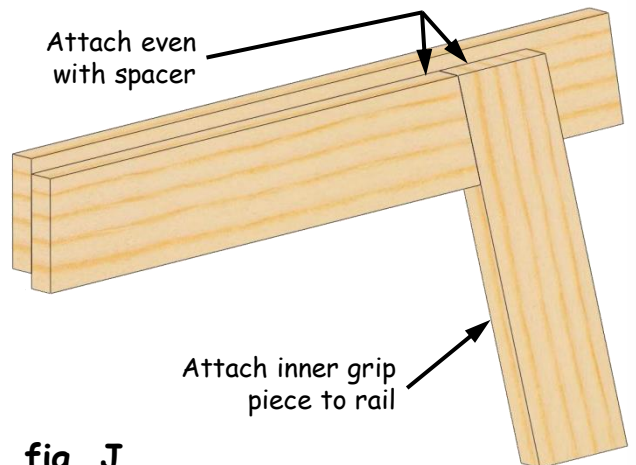
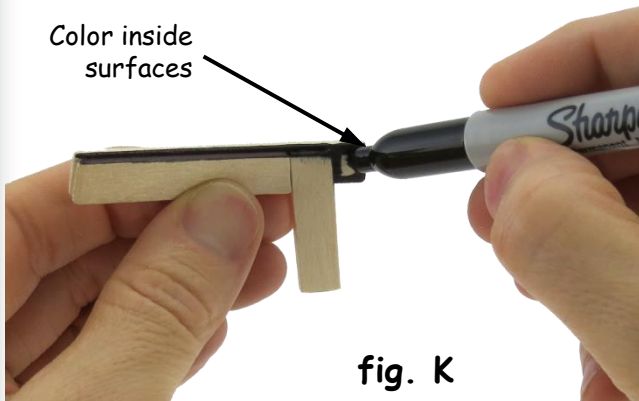

fig. J

Rev:02/05/14



### Step 11

Use a black permanent marker to color the surfaces along the top of the spacer and inside of the rail, and behind the inner grip piece as shown. These locations are difficult to reach after assembly. (fig. K)

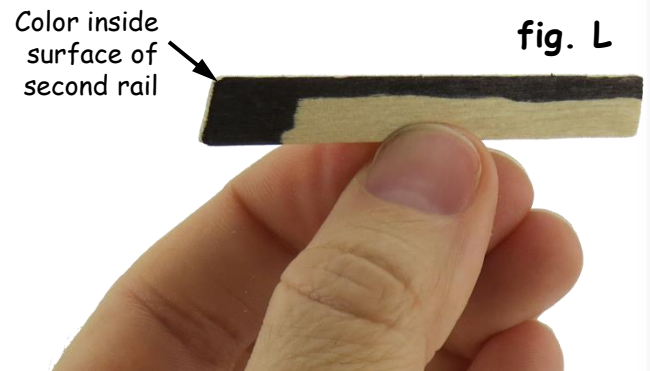

### Step 12

Color the inside surface of the second rail piece in the area shown. (fig. L)

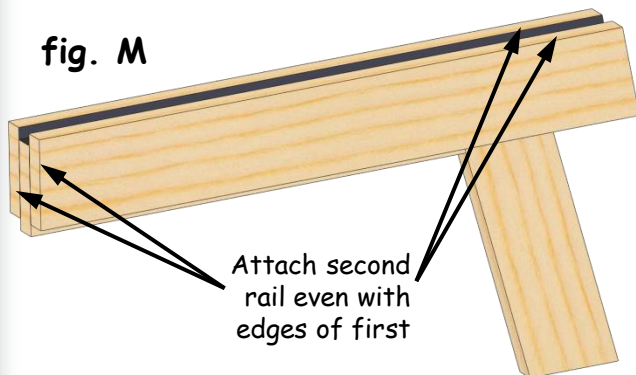

### Step 13

Use a thin bead of glue to attach the second rail piece with the outside edges exactly even with the first rail as shown. (fig. M)

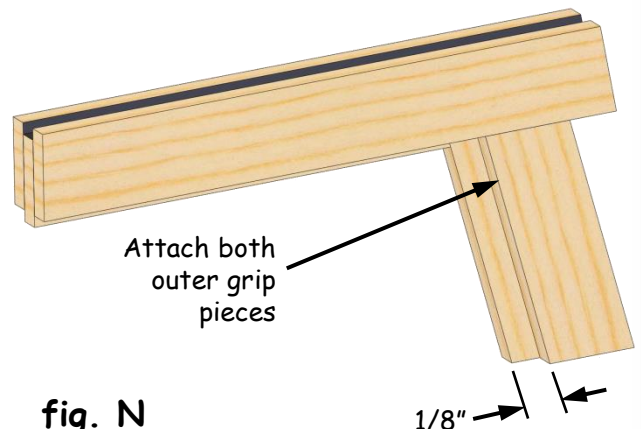

### Step 14

Attach each outer grip piece 1/8" back from the front edge of the inner grip piece as shown. (fig. N)



Fig. O

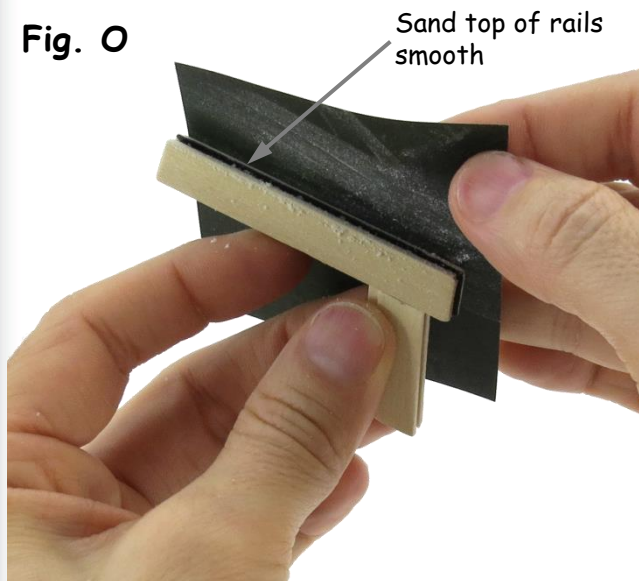

### Step 15

Use a piece of 400 grit sandpaper to sand the top of each rail smooth to prevent the bowstring from fraying and breaking. Sand a rounded corner on each outside edge. (fig. O)

**Sonic Tip:** Using 400 grit sandpaper on the top of the rails will make them smooth without removing much material. A smooth top surface and rounded edges will keep the bowstring from wearing out too quickly. Bowstring failure is a real bummer!



### Step 16

After sanding, the top of each rail should be smooth with a rounded corner on each outside edge as shown. (fig. P)

Top edge should be smooth with rounded corners

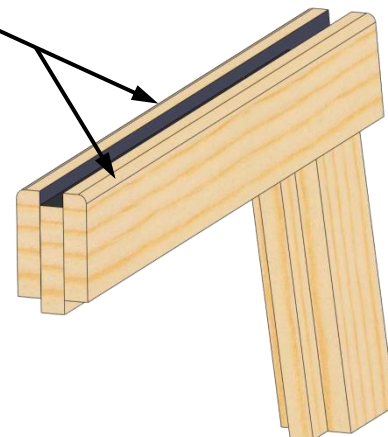

Fig. P

Break off center tab

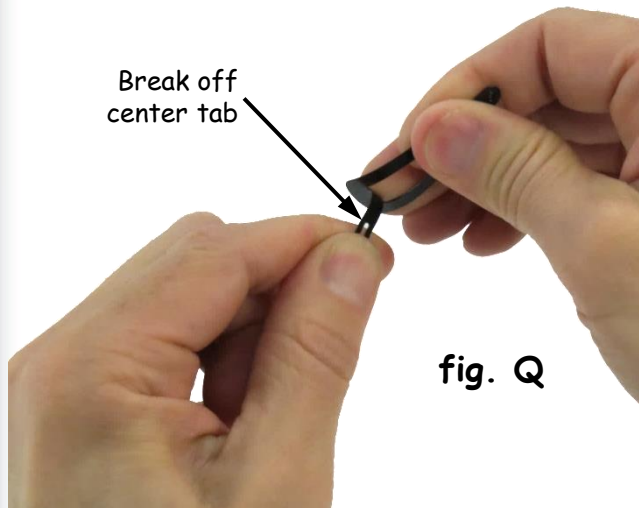

fig. Q

### Step 17

Bend the center tab of a hair clip over until it breaks off at the base. You will need two clips for your bow limbs. (fig. Q)

Rev:02/05/14

### Step 18

Apply a small bead of glue on one end of the limb support piece as shown. Use the support piece without the center markings. (fig. R)

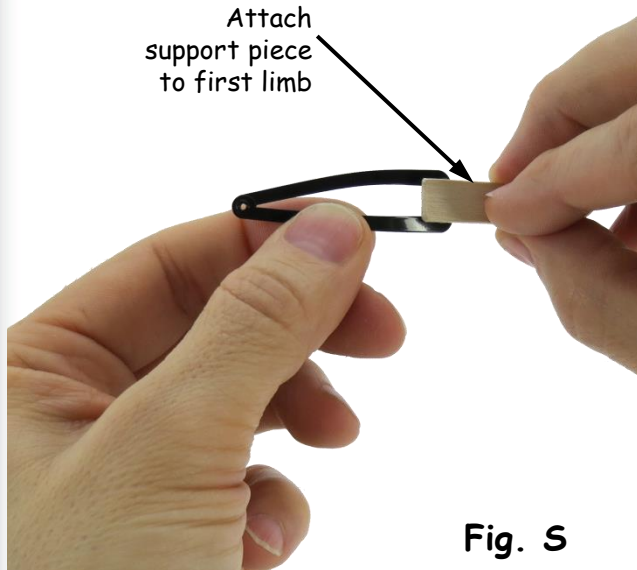

Fig. S

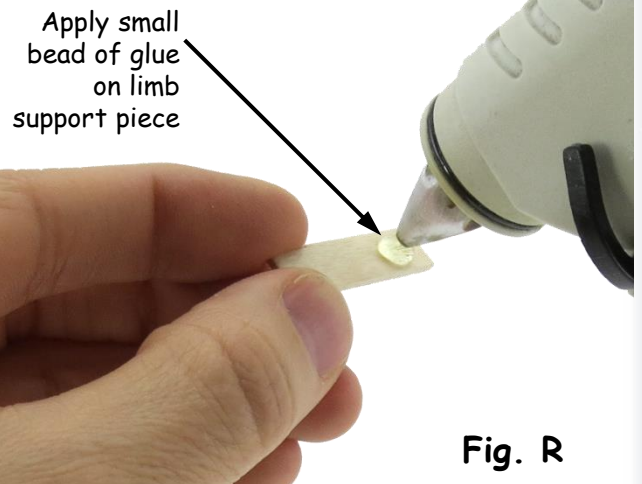

Fig. R

### Step 19

Working quickly while the glue is still hot, attach the limb support piece to one of the limbs. Position the support centered on the limb and covering the rough inside edge of the limb as shown. (fig. S)

### Step 20

Apply a small bead of glue on the support and attach the second limb as shown. (fig. T)

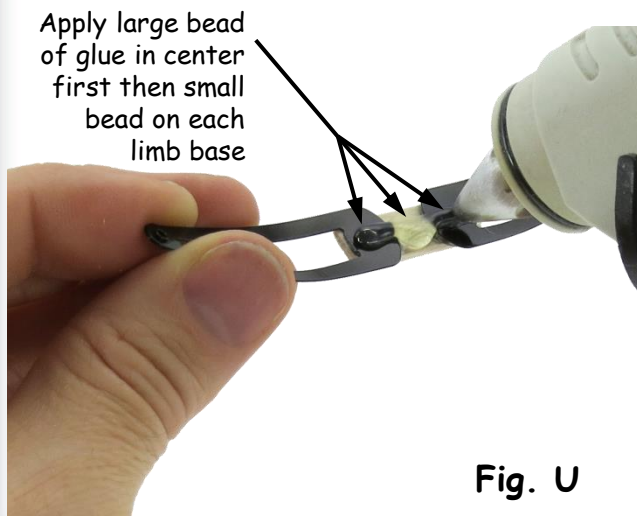

Fig. U

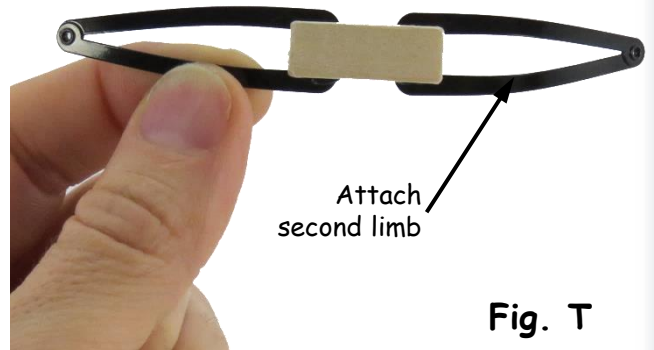

Fig. T

### Step 21

Apply a large bead of glue on the support piece first, then quickly apply a small bead on each limb base as shown. (fig. U)

## Step 22

Working quickly while the glue is still hot, attach the second limb support with center markings as shown. Be sure the edges are even with the first support piece as shown. (fig. V)

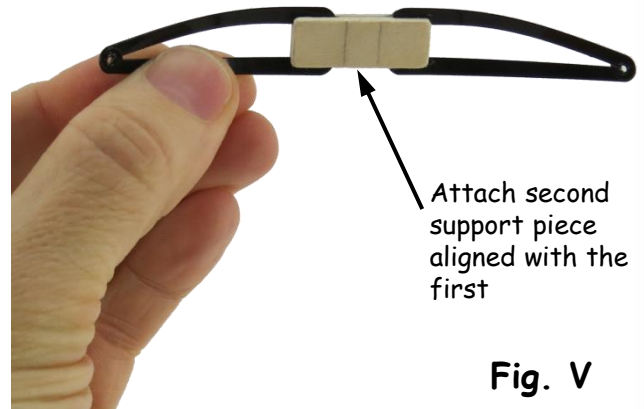
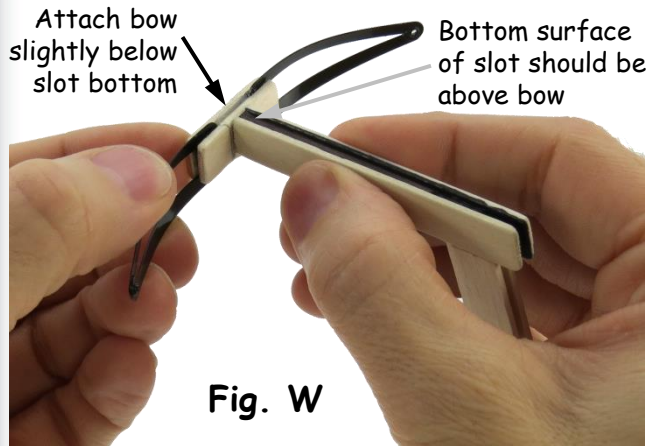

## Step 23

Apply a small bead of glue on the front surface of the frame below the slot. Working quickly while the glue is still hot, attach the bow using the center markings on the support as a guide. Attach the bow with the top surfaces of the supports just BELOW the bottom surface of the slot. This will allow the crossbow bolts to slide freely thru the slot without touching the limb support pieces. (fig. W)

## Step 24

Apply a small bead of glue on each side of the frame to strengthen the glue joint as shown. (fig. X)

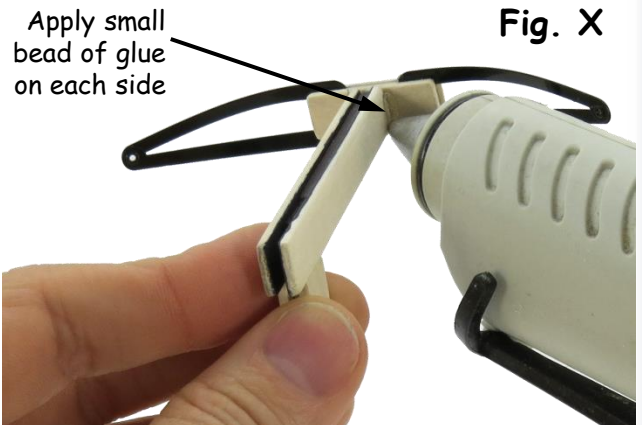
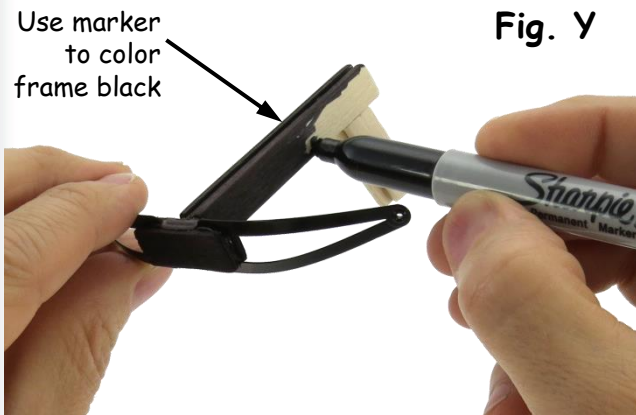

## Step 25

Use a black permanent marker to finish coloring the frame and limb supports as shown. (fig. Y)

Rev:02/05/14

## Step 26

Cut a piece of embroidery floss, the color of your choice, about 60" long. Use a small bead of glue to attach one end of the floss between the outer grip pieces as shown. (fig. Z)

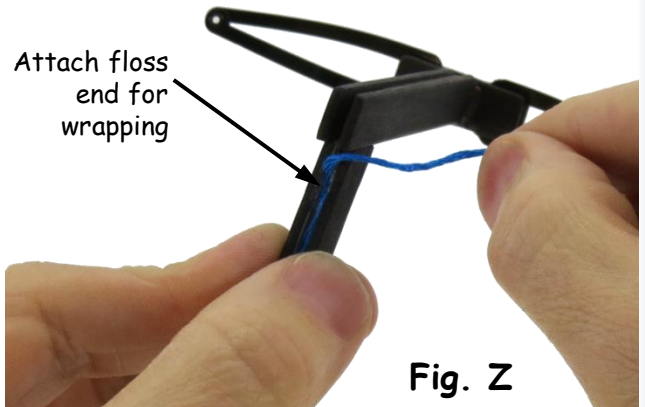
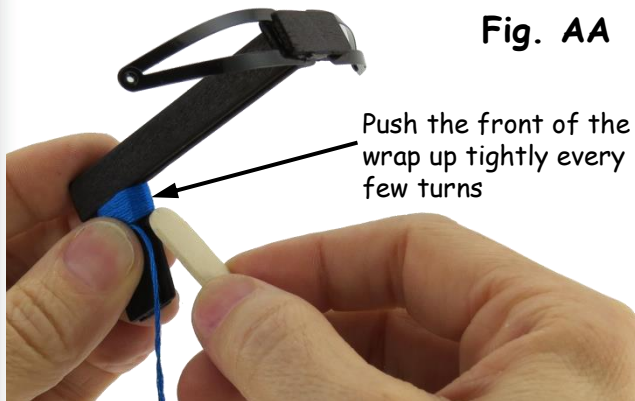

Fig. AA



## Step 27

Begin to tightly wrap the floss carefully around the grip as shown. It is helpful to twist the floss as you go for a more even looking wrap. As you work your way down the grip, you may need to push the front of the wrap up tightly every few turns with a popsicle stick to keep the wrap parallel with the frame as shown. (fig. AA)



**Sonic Tip:** I like to twist the floss as I wrap to keep the floss diameter more consistent. This makes for a better looking wrap. I like to wrap a few turns, then twist the floss before making a few more wraps. I also like to push the front of the wrap up tightly every few turns with a popsicle stick like this. That way the wrapping stays parallel with the frame rails and bottom of the grip.

Fig. BB

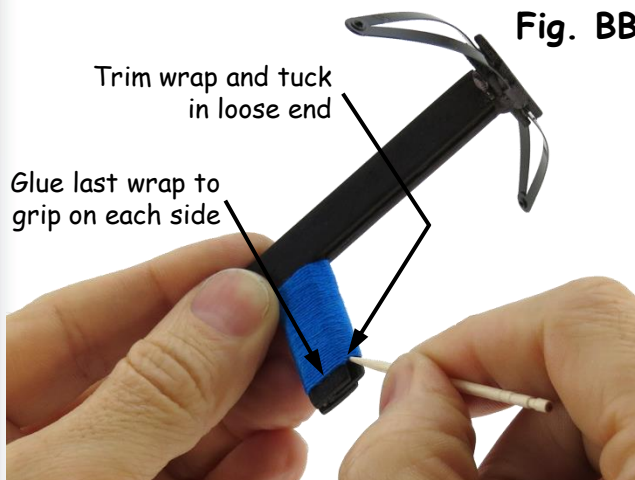

## Step 28

Wrap down to 1/8" from the bottom of the grip. Use a very small bead of glue to secure the last wrap on each side of the grip. Trim the floss with scissors, leaving a 1/8" tail. Use a toothpick or other small pointed object to tuck the loose end up inside the wrapping as shown. (fig. BB)

Rev:02/05/14

## Step 29

Mark the location of the bowstring grooves with a pencil on the top of each rail. Locate the pencil marks on each rail directly above the point where the grip and rail meet as shown. (fig. CC)

Make a vertical cut about 1/32" deep on groove marks

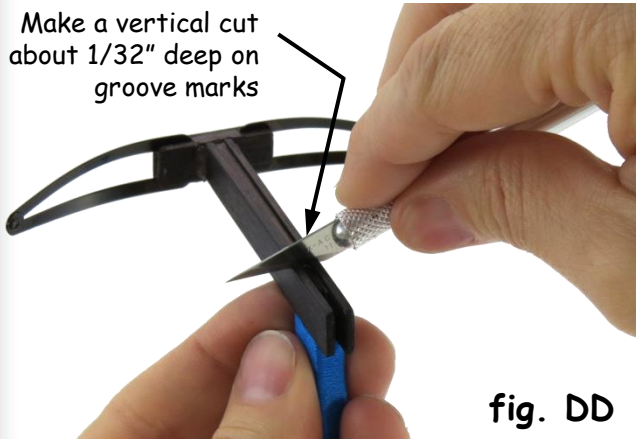

fig. DD

Mark bowstring groove locations

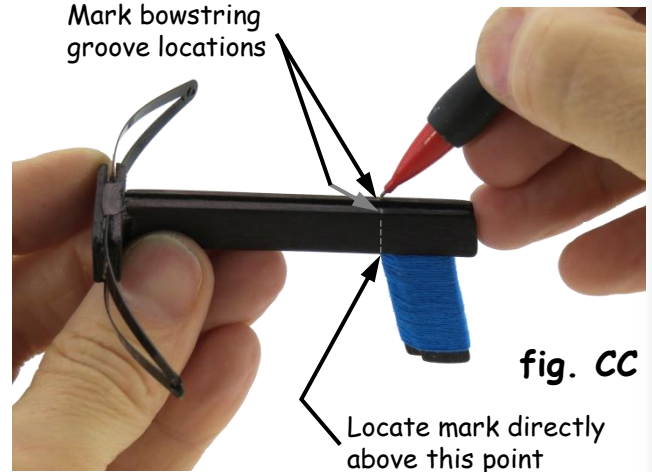

fig. CC

## Step 30

Carefully locate your X-acto knife blade on the groove marks. Press the blade down firmly to make a vertical cut on both rail about 1/32" deep as shown. (fig. DD)

Make shallow angled cuts up to the vertical cut until 1/32" deep



Fig. EE

The bowstring grooves are a little bit tricky - like sticking a crosswind landing - but you can do it! Start with a good clean vertical cut with a sharp blade about 1/32" deep, or just a bit deeper. Starting on one rail, make a shallow angled cut, stopping at the vertical cut. The trick is to only take a little off at a time. Make a few thin passes until the groove is about 1/32" deep, or about the diameter of the twisted embroidery floss. If in doubt, keep the grooves shallow - we will make final adjustments to the grooves in a later step.



## Bowstring Groove Detail

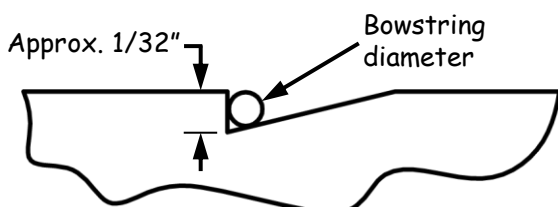

Fig. FF

## Step 31

Create bowstring grooves by making a shallow angled cut on each rail, stopping on the vertical cut as shown. Make a few thin cuts until each groove is about 1/32" deep (about the diameter of the bowstring). (fig. EE) See fig. FF for an enlarged detail drawing of the groove.

### Step 32

Cut a piece of floss about 12" long. Moisten one end and thread it through the small hole in the end of one of the bow limbs as shown. (fig. GG)

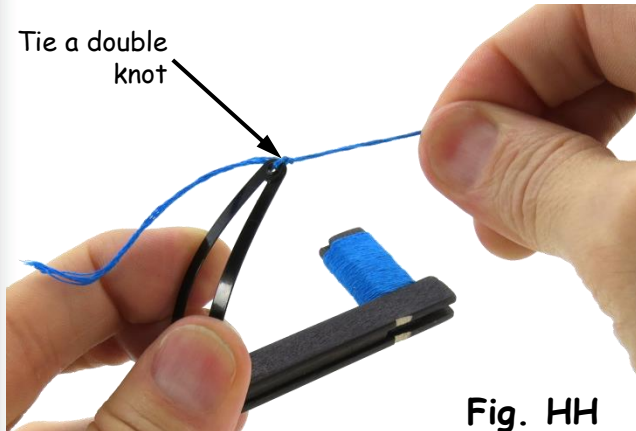

Fig. HH

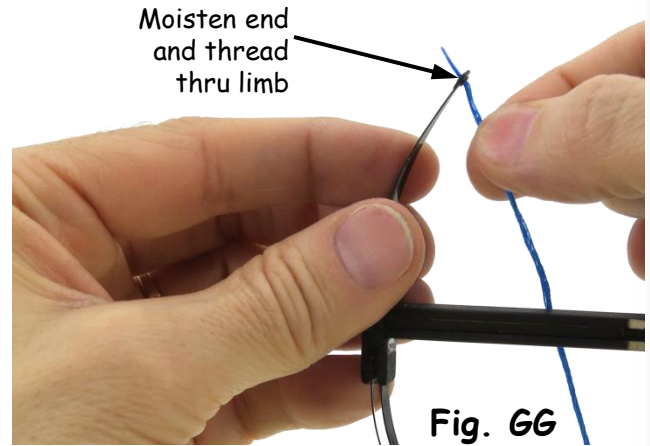

Fig. GG

### Step 33

Tie a tight double knot in the floss, then pull the floss tightly to secure the knot. (fig. HH)

### Step 34

Thread the second end of the bow string through the second limb. Twist the bowstring several times until it is tight as shown. (fig. II)

Fig. II

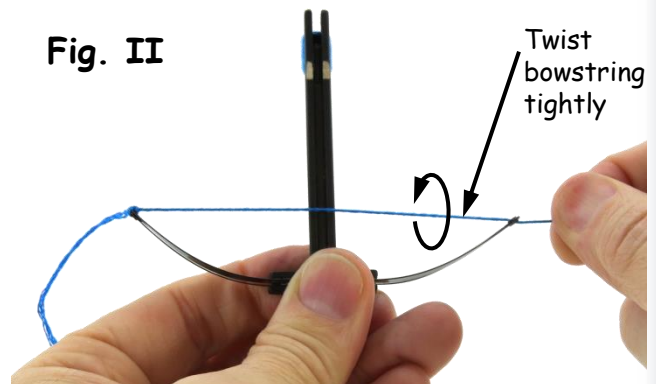
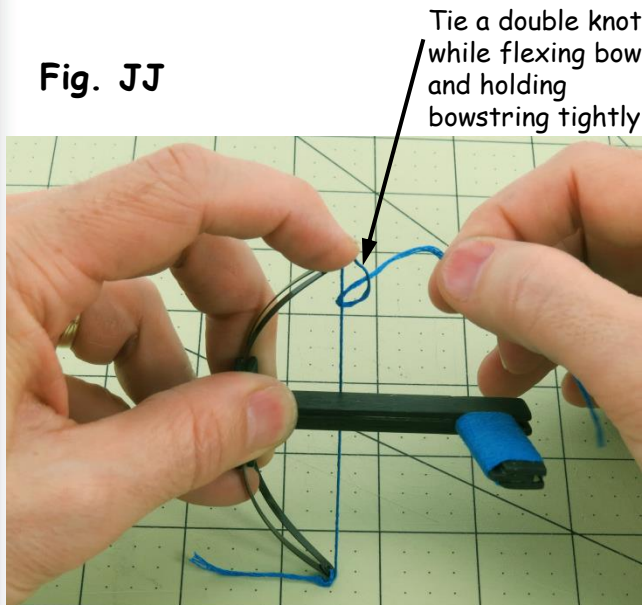

Fig. JJ



### Step 35

Place the crossbow on your work surface as shown. Flex the bow as you keep your finger tightly on the tip of the limb to keep tension on the bowstring and to keep it from untwisting. Flex the bow enough to space the bowstring about 1" from the front of the bow. Tie a double knot in the bow string with your other hand. (fig. JJ)

Rev:02/05/14

### Step 36

Pull the floss tightly to secure the double knot. Check the distance between the bowstring and the front of the bow as shown. About 1" between the two points will provide the correct tension in the bowstring. (fig. KK)

Trim each end and apply glue around each knot



fig. LL

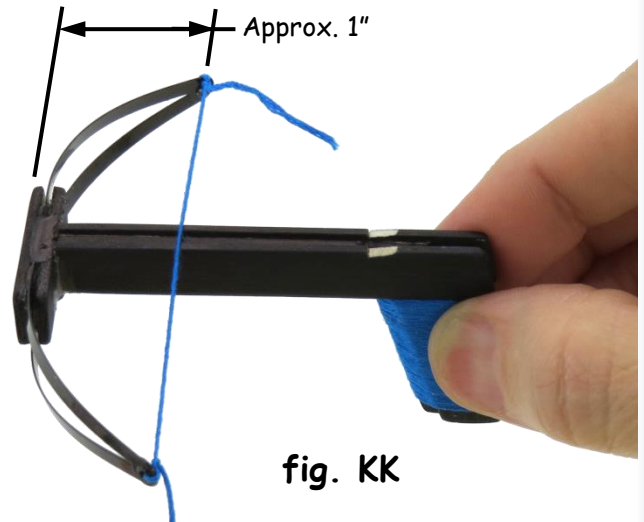

fig. KK

### Step 37

Use scissors to trim the extra bowstring on each end. Apply a very small bead of glue around each knot to prevent them from coming loose. (fig. LL)

### Step 38

Pull the bowstring back with a finger on each side of the frame to test the bowstring grooves. If the grooves are the correct depth, the string will lock in place, and will only require slight upward pressure with your thumbnail to release. If the grooves are too shallow the bowstring will not lock in place. If so, remove a little more material in the grooves to allow the bowstring to lock securely. Be careful not to make the grooves too deep, as this will make it more difficult to fire your crossbow. (fig. MM)

Fig. MM

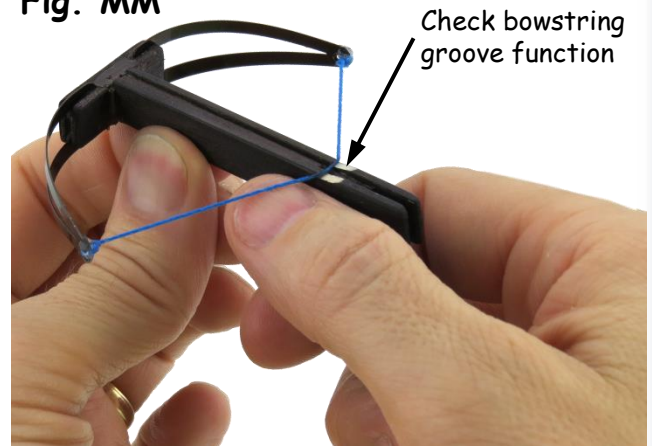

Color bowstring grooves with marker

Fig. NN

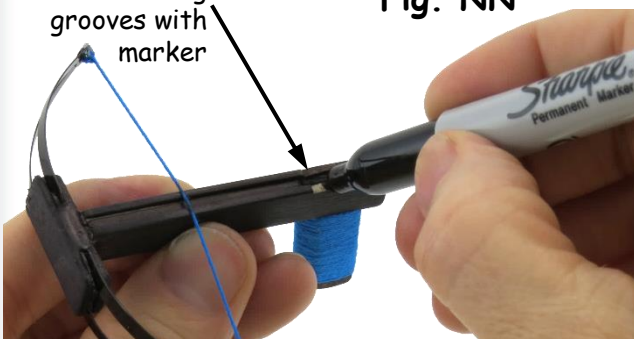

### Step 39

After you are finished testing and tuning the bowstring grooves, use a marker to color them black as shown. (fig. NN)

Rev:02/05/14

## Target Construction

### Step 1

Print the target assembly template/decalsheet from page 20 on a full sheet printer label. Roughly cut around the target decal. Peel the label backing and apply to a piece of poster board. Cut the target out on the cut line as shown. (fig. OO)

Roughly cut target decal and apply to poster board

Cut target out

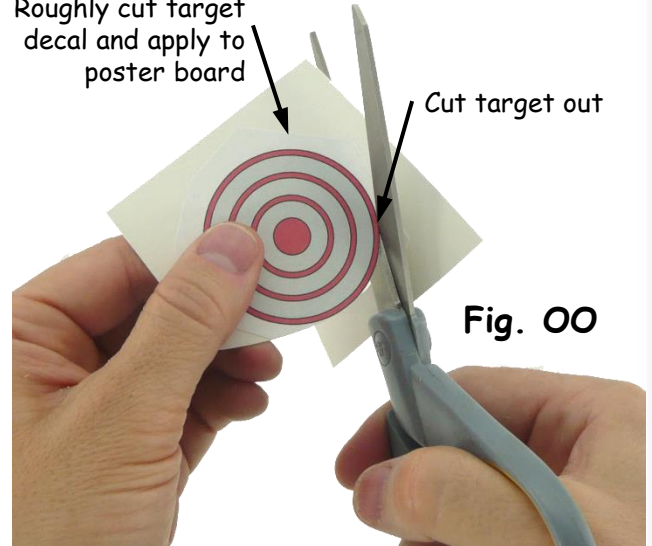
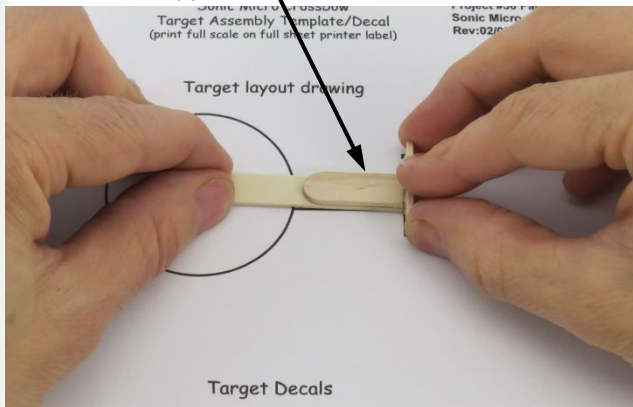

Fig. OO

Use layout drawing to assemble target support

fig. PP



### Step 2

Assemble the target support using the layout template as shown. (fig. PP)

### Step 3

Attach the target graphic to the support with glue as shown. (fig. QQ)

fig. QQ

Glue target graphic to support

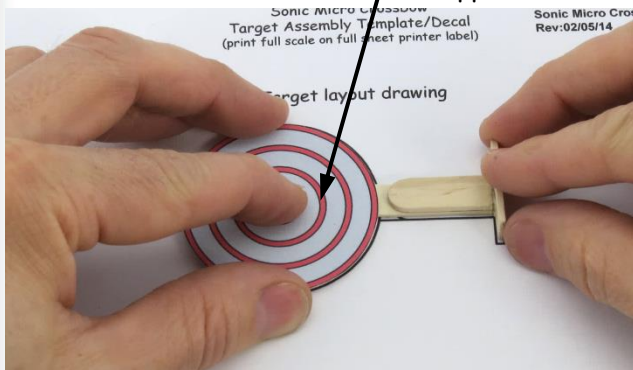



## Shooting Your Micro Crossbow



I'll show you how to shoot your crossbow in a few easy steps.

**Step 1:**  
Hold the crossbow with your right hand like this. Then pull the bowstring back with your left hand using a finger on each side of the frame like this. Pull the string back until it locks into the bowstring grooves... cool!

**Step 2:**  
Now load your crossbow bolt of choice. Place the bolt in the slot between the rails and in front of the bowstring like this. The safest bolt for kids is a modified cotton swab. Just cut one end off with scissors and you have a great crossbow bolt!

I also like to shoot wood matchsticks from my crossbow because they fly a bit straighter and further than swabs - but you have to be careful! Only shoot matchsticks outside with adult supervision! A good pilot is also a safe pilot!





**Step 3:**

With your bolt loaded and ready, hold the crossbow frame with your left hand like this. Hold the crossbow grip with your right hand and place your right thumb under the bowstring like this. Now take aim and gently lift up on the bowstring with your thumb to fire. . . Cool! That's all there is to it! Have Fun!



**Notice to Airmen:**

The Sonic Micro Crossbow is a lot of fun to use, but if misused it can also cause serious injury. **Never** point or shoot the crossbow at people or animals. **Always** point the bolt in a safe direction away from anyone or anything breakable. **Always** shoot at inanimate targets. **Never** shoot matches from the crossbow indoors or without adult supervision! Please use the Micro Crossbow safely, and have fun!



Sonic Micro Crossbow  
Cutting Templates  
(print full scale on printer paper)

Project #56 Page 19/20  
Sonic Micro Crossbow  
Rev:02/05/14

Inner Grip Qty. 1  
(regular popsicle stick)

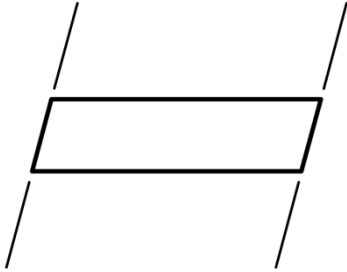

Outer Grip Qty. 2  
(regular popsicle stick)

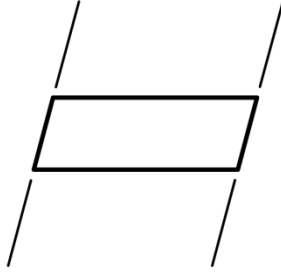

Limb Support Qty. 2  
(regular popsicle stick)

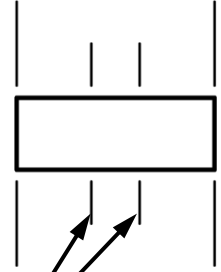

Mark center lines on one piece  
(see Step 2)

Rail Qty. 2  
(regular popsicle stick)

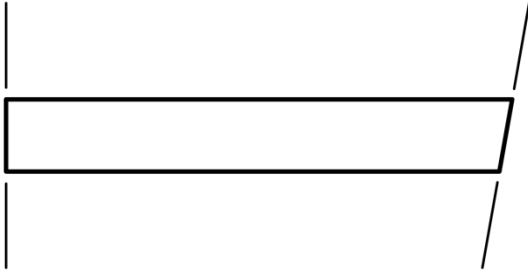

Rail Spacer Qty. 1  
(regular popsicle stick)

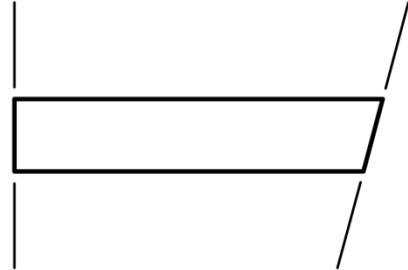

Target Support Qty. 1  
(regular popsicle stick)

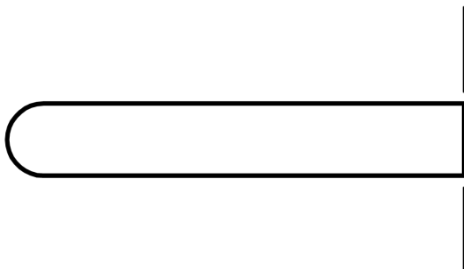

Base Support Qty. 1  
(regular popsicle stick)

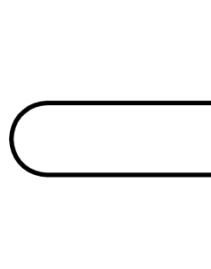

Target Base Qty. 1  
(regular popsicle stick)

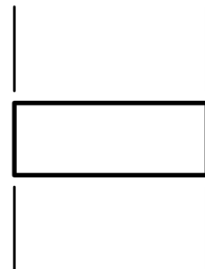

### Target Layout Template

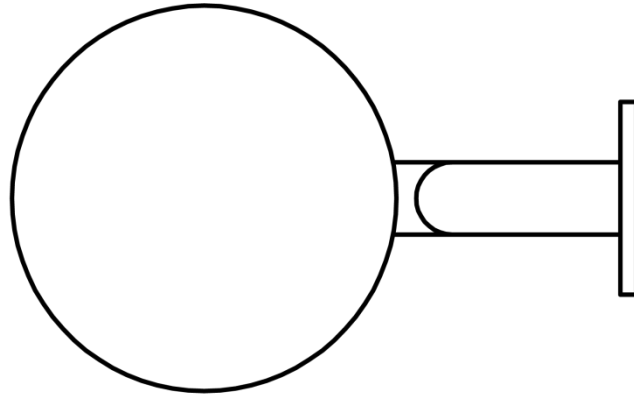

### Target Decals

